



CHILLED WATER COIL-CASSETTE TYPE

# 40VNS-W Series

19,900-67,800 BTU/H



# Model number Nomenclature

**40VNS 018 W - 1 0 F R**

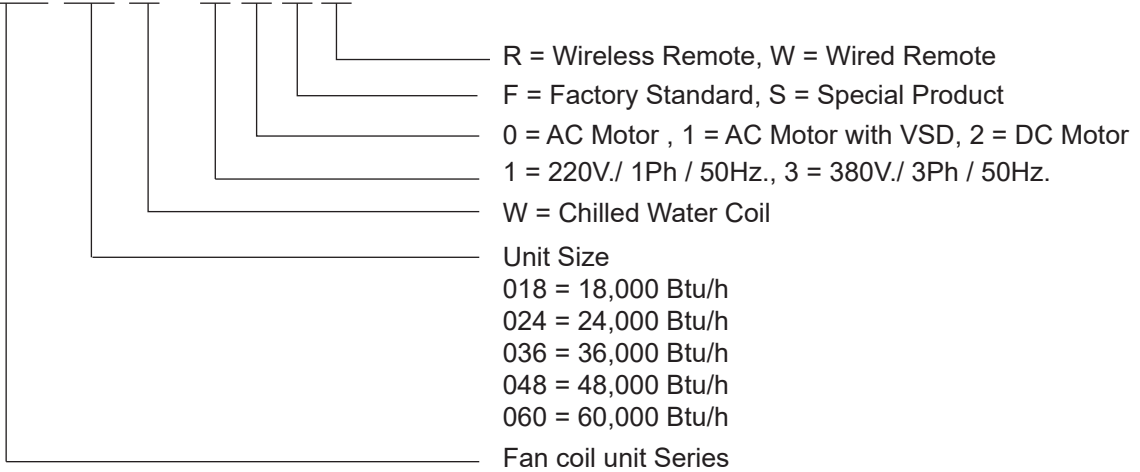

## Features ►



### Motor and Fan

- Optimized designed centrifugal fan design  
High efficiency.
- Quiet running with anti-vibration pads of motor.



### Coil blue fin

Blue fin with Epoxy and Hydrophilic coating  
Prevents dirt from sticking to the fins.



### Built-in drain pump

Unit complete with built in high lift drain pump.  
(Rising up to 661 mm. or less)

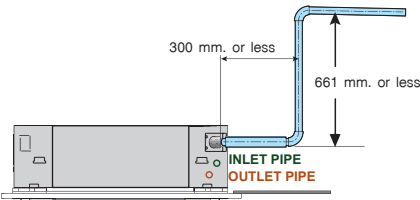

### Fresh air

Fresh air intake port for high quality air supply  
requirement, creates more comfort and healthy  
environment.



For fresh air (knockout)

## Swing operation

Uniform air distribution in room for better comfort through  
4 louvers.



The wide air flow in all direction

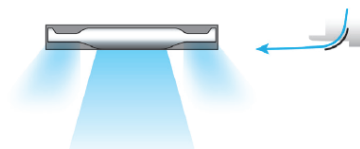

## Space required for installation and servicing

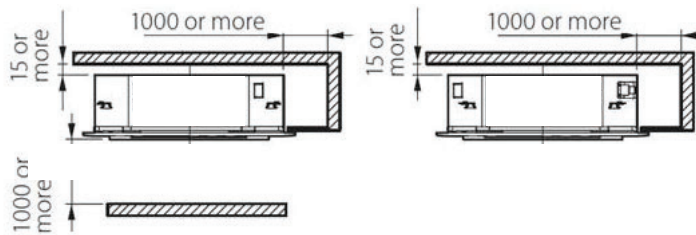

## Accessories (Optional)

### BAS controller (Option)

#### Model CARR-INTM9DT09X

- Open communication protocol Modbus RS-485
- Manages the DC motor or EC motor
- Manages the valve actuator proportional type
- External contract for key card ON-OFF

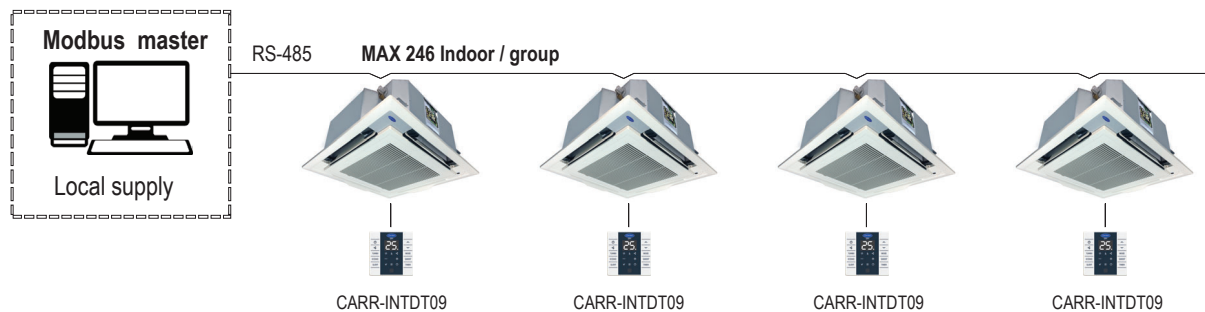

### Nano Silver Titanium Filter Technology (Option)

#### Ag-TiO<sub>2</sub> Properties

- Get rid of bad odor
- Nano coating filter
- Non UV active
- Environmentally friendly
- Self bacteria killed, anti-virus and fungi

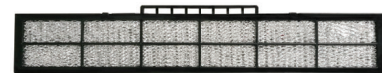

### Built in PICV (Option)

Factory assembled nest of valves and accessories help installers avoid installation mistakes onsite.

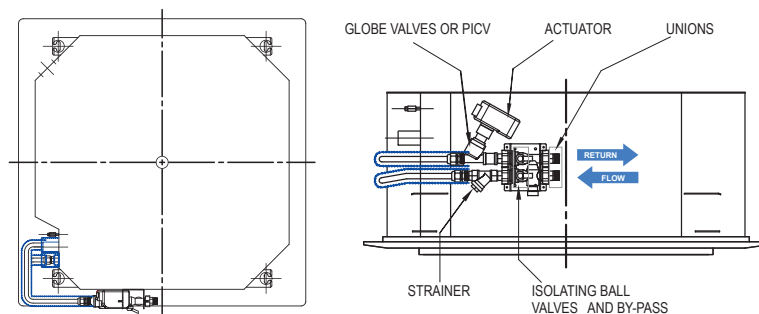





### ► 4 Way Air flow

ลมเย็นเป่ากระจายออกทั้ง 4 ทิศทาง พร้อมบานสวิงปรับระดับกระจายลม ให้ทั่วถึงทุกมุมห้องโดยอัตโนมัติ เพื่อความเย็นสบาย ตามที่คุณต้องการ



Wireless Remote Control (Standard)



CARR-INTDT09 (Option)



CARR-INTDT09-WiFi (Option)

Specification (รายละเอียดของเครื่อง)		Chilled Water Coil - 4Way Cassette Type (ฝั่งฟ้า 4 ทิศทาง)					
Model Name(ชื่อรุ่น)	Indoor (เครื่องภายใน)	40VNS					
		018W	024W	036W	048W	060W	
Cooling Capacity (ความสามารถในการทำความเย็น)	W	5,832	9,056	12,192	15,123	19,871	
	Btu/hr.	19,900	30,900	41,600	51,600	67,800	
Power Supply (ระบบไฟฟ้า)	V/Ph/Hz	220/1/50					
Power Consumption (กำลังไฟฟ้า)	W	62	66	150	160	252	
Operating Current (กระแสไฟฟ้า)	Amp.	0.30	0.32	0.73	0.77	1.16	
Indoor Air Circulation, Max. (ปริมาณลมหมุนเวียน)	m <sup>3</sup> /h	1,360	1,360	2,040	2,380	2,720	
	cfm	800	800	1,200	1,400	1,600	
Sound Pressure Level (ระดับ) (Turbo/H/M/L)	dBA	35/32/28/25	40/35/30/26	49/47/40/35	49/47/41/36	56/52/47/41	
Dimension - Indoor unit (ขนาดของเครื่อง)	Front Grill Panel	mm. 30 x 950 x 950					
	Ceiling Open	mm. 880 x 880					
Height x Width x Depth	Housing	mm. 285 x 840 x 840			mm. 335 x 840 x 840		
Net Weight (น้ำหนักเครื่อง)	Front Grill Panel	kg. 4	kg. 4	kg. 4	kg. 4	kg. 4	
	Housing	kg. 30	kg. 35	kg. 36	kg. 39	kg. 41	
Connecting Pipe - Indoor (ขนาดท่อที่ใช้)	Water Inlet (FPT)	inch 1/2	inch 1/2	inch 1/2	inch 1/2	inch 1/2	
	Water Outlet (FPT)	inch 1/2	inch 1/2	inch 1/2	inch 1/2	inch 1/2	
	Drain O.D. (ท่อน้ำทิ้ง)	mm. 32	mm. 32	mm. 32	mm. 32	mm. 32	

Remark : 1.) FPT = Female Water Pipe Thread

2.) Nominal capacity are base on air entering temp. 80 degree° Fwb / 67 degree° Fcb , Entering/Leaving water temp. 44/54 degree° F, at max air flow rate

## Performance Data

Model	Entering water Temperature (°F)	Entering Air Temperature (°F db/°F wb)															
		76/63				78/65				80/67				82/69			
		TH	SH	GPM	FT.WG	TH	SH	GPM	FT.WG	TH	SH	GPM	FT.WG	TH	SH	GPM	FT.WG
40VNS018W	40	18,400	15,700	3.67	11.83	21,600	16,700	4.31	15.64	24,900	17,700	4.97	20.12	28,400	18,700	5.66	25.31
	45	13,500	13,100	2.69	6.74	15,600	14,100	3.11	8.68	18,600	15,200	3.71	11.80	22,000	16,200	4.39	15.88
	50	10,300	10,300	2.06	4.17	11,500	11,500	2.30	5.04	13,100	12,600	2.62	6.33	15,400	13,600	3.08	8.35
40VNS024W	40	28,600	21,500	5.69	7.94	33,000	23,000	6.57	10.22	37,600	24,500	7.49	12.85	42,400	25,900	8.45	15.86
	45	20,700	17,800	4.13	4.46	24,400	19,200	4.86	5.91	29,100	20,800	5.81	8.07	34,000	22,300	6.78	10.55
	50	14,600	14,600	2.92	2.40	17,300	15,900	3.46	3.22	20,500	17,100	4.09	4.29	24,400	18,500	4.88	5.82
40VNS036W	40	38,500	29,900	7.67	13.36	44,600	31,900	8.89	17.31	51,000	33,900	10.16	21.87	57,600	35,900	11.48	27.11
	45	27,900	24,700	5.58	7.50	32,800	26,600	6.54	9.91	39,100	28,900	7.81	13.51	45,800	30,900	9.13	17.78
	50	19,800	19,800	3.95	4.05	23,300	22,100	4.66	5.39	27,500	23,700	5.50	7.18	32,700	25,700	6.54	9.70
40VNS048W	40	47,700	36,600	9.51	13.18	55,300	39,100	11.02	17.05	63,200	41,600	12.58	21.52	71,300	44,000	14.21	26.65
	45	34,800	30,300	6.95	7.46	40,800	32,700	8.14	9.84	48,600	35,400	9.70	13.36	56,800	37,900	11.33	17.56
	50	24,600	24,600	4.91	4.00	29,100	27,200	5.82	5.37	34,300	29,100	6.86	7.16	40,800	31,400	8.15	9.65
40VNS060W	40	62,800	46,300	12.51	13.01	72,100	49,400	14.37	16.58	82,000	52,600	16.33	20.75	92,300	55,800	18.38	25.53
	45	46,300	38,600	9.24	7.51	54,300	41,400	10.84	9.92	64,100	44,700	12.80	13.25	74,300	47,900	14.82	17.13
	50	32,700	31,700	6.53	4.04	38,500	34,300	7.69	5.35	46,000	37,000	9.18	7.28	54,600	39,800	10.90	9.82

Note : Water Temperature Rise 10°F



Front Grill Panel  
Model 40TS-00L--10FR

บริษัท แคนเรียร์ (ประเทศไทย) จำกัด  
1858/63-74 ชั้น 14, 15  
ถ.เทพรัตน กม. 4.5 แขวงบางนาใต้  
เขตบางนา กรุงเทพฯ 10260  
โทร. 0-2090-9999 แฟกซ์: 0-2751-4778

Carrier (Thailand) Ltd.  
1858/63-74 , 14<sup>th</sup>, 15<sup>th</sup> Floor,  
Debaratna Road, Km.4.5, Bangna Tai,  
Bangna Bangkok 10260 Thailand  
Tel. 0-2090-9999 Fax: 0-2751-4778

บริษัทฯ ขอสงวนสิทธิ์ที่จะเปลี่ยนแปลงรายละเอียดข้างต้น โดยไม่ต้องแจ้งให้ทราบล่วงหน้า  
Carrier reserves the right to make changes in specifications without prior notice.



YOUR CARRIER MAN :